







Memory Pressure Gauges: **Basic Production Logging Tool**

Features

-  Pressure
-  External Fast Response Temperature Probe
-  Casing Collar Locator
-  Easy to Use
-  Welded Sensors
-  Inconel 718 – NACE MR0175

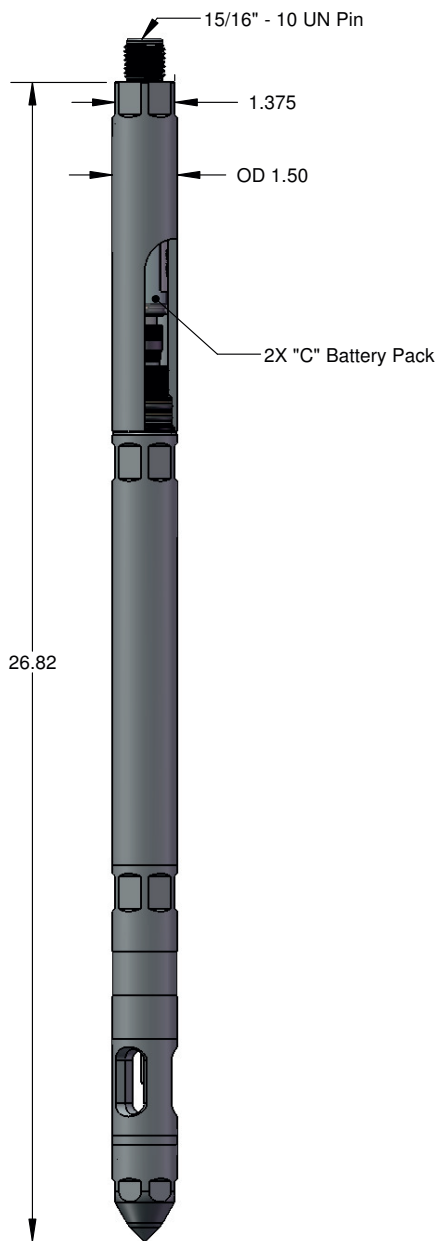

1.50" OD Basic Production Logging Tool - Inconel 718		
Pressure	Temperature	Part No.
3,000 psi	150°C	105143
6,000 psi		105144
10,000 psi	177°C	105112
15,000 psi		105145
20,000 psi		105146

Accessory Type	Part No.
Bullnose SS316	105140
Crossover 15/16-10 UNC (5/8" Sucker Rod) SS316	105233
Battery Barrel 1 x "CC" Inconel 718	105123
Pelican Case Assembly	105125
Redress Kit Viton 90	105126
Redress Kit Aflas	105127
Redress Kit Chemraz	105128

Specifications			
	Pressure	Temperature	Accelerometer
Accuracy	0.050% F.S.	0.25°C	0.1 g
Resolution	0.0003% F.S.	0.01°C	0.01 g
Drift	< 3 psi / year	< 0.1°C / year	-

Casing Collar Locator	
Detector Type	Electromagnetic
Memory	
Sample Rate	0.1 sec to 1.82 hours
Capacity	2 Million Samples
Communication	USB