







Memory Pressure Gauges: **1.75" Geothermal**

Features

-  8 hours @ 300°C (600°F)
-  External Fast Response Temperature Probe
-  Casing Collar Locator
-  0.1s Fast Sample Rate Option
-  Pressure Trigger Option
-  1 Million Sample Capacity
-  Inconel 718 – NACE MR0175

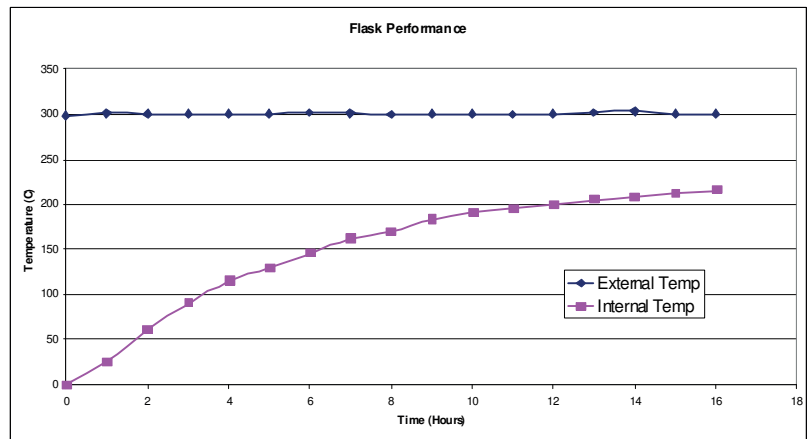
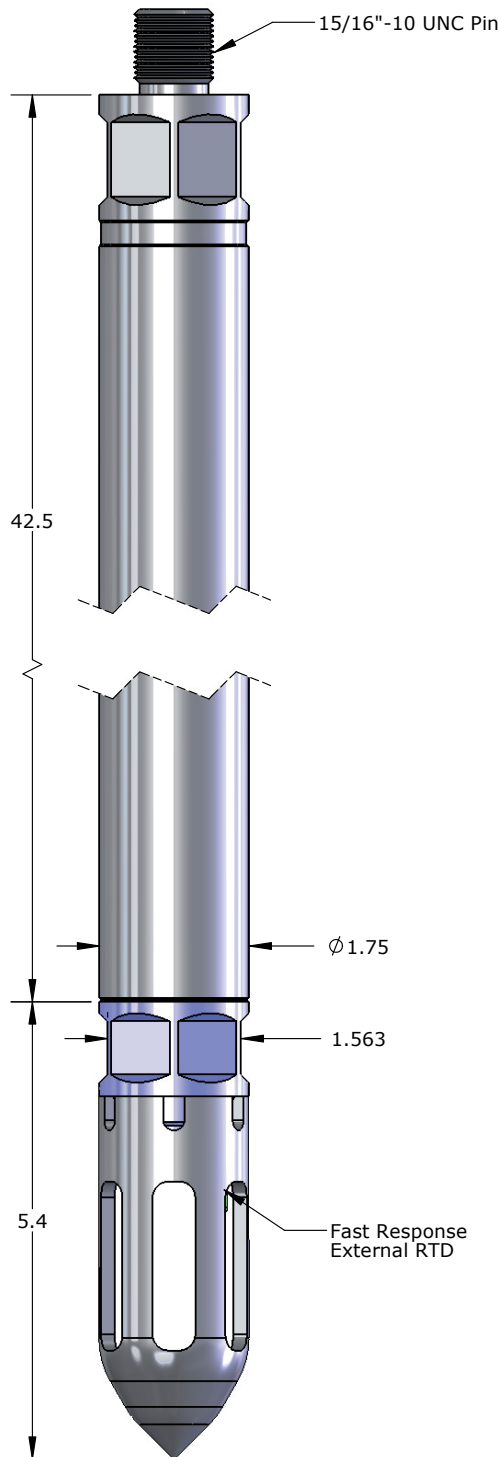

1.75" OD Geothermal Memory Tool - Inconel 718	
Pressure	Part No.
750 psi	100502
1,500 psi	100503
3,000 psi	100504
6,000 psi	100505
10,000 psi	100506
15,000 psi	100507
20,000 psi	100508

Accessory Type	Part No.
Bullnose SS316	100511
Crossover 15/16-10 UNC (5/8" Sucker Rod) SS316	100562
Casing Collar Locator	101675
Pelican Case Assembly	100526
Redress Kit Viton 90	101672
Redress Kit Aflas7182B	101673
Redress Kit Chemraz 510	101674

Specifications		
	Pressure	Temperature
Accuracy Up To	0.022% F.S.	0.25°C
Resolution	0.0003% F.S.	0.005°C
Drift	< 3 psi / year	< 0.1°C / year
Capacity	1 Million Samples	
Communication Method	USB	